

## 2/2-Wege Coaxialventil 2/2-way coaxial valve

## Baureihe 283-X Type 283-X

fremdgesteuert  
Modulbauweise

externally controlled  
modular design

Schaltfunktion A: NC (stromlos geschlossen)  
function A: NC (normally closed)

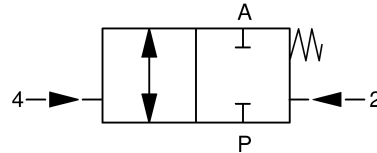

Schaltfunktion B: NO (stromlos offen)  
function B: NO (normally open)

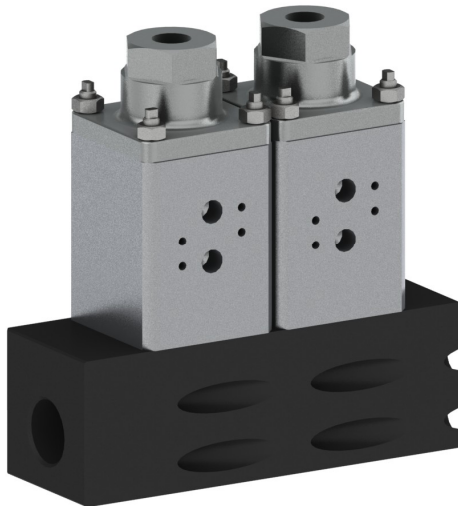
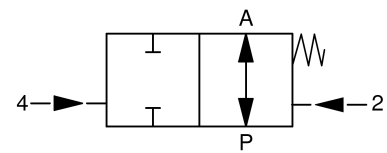

<b>Nennweite</b>	DN 15	<b>diameter</b>	DN 15
<b>Druckbereich</b>	0 – max. 200bar Gegendruckdicht bis max.16bar	<b>pressure range</b>	0 – max. 200bar backpressure leakproof up to max. 16bar
<b>Gehäusewerkstoff</b>	Einzelventil: Messing Block: Aluminium	<b>body material</b>	single valve: brass block: aluminium
<b>Dichtwerkstoff</b>	statisch: FKM dynamisch: PTFE Sitzdichtung: PTFE	<b>seal material</b>	static: FKM dynamic: PTFE seat seal: PTFE
<b>Temperatur</b>	Medium: -10 bis +100°C Umgebung: -10 bis +50°C	<b>temperature</b>	media: -10 up to +100°C ambient: -10 up to +50°C
<b>Anschluss</b>	Ventil: G3/8 – G3/4 Block: G1 1/4	<b>connection</b>	valve: G3/8 – G3/4 block: G1 1/4
<b>Durchflußrichtung</b>	P → A max. 200bar A → P max. 16bar	<b>flow direction</b>	P → A max. 200bar A → P max. 16bar
<b>Antriebsteil</b>	doppelt wirkender Kolben mit Rückstellfeder	<b>actuating part</b>	double acting piston with spring return
<b>Steuerdruck</b>	3 – 8bar Anschlüsse 2+4 (G1/4) Schnittstelle nach NAMUR	<b>control pressure</b>	3 – 8bar connections 2+4 (G1/4) port according to NAMUR
<b>Schaltzeiten</b>	eine vorgeschaltete Wartungseinheit verlängert die Lebensdauer der Ventile  Öffnen / Schließen 50 – 1000ms Abhängig vom Steuerdruck, Pilotventil (Option) und Abluftdrosseln (Option)	<b>switching time</b>	an upstream service unit extends the lifetime of the valves  opening / closing 50 – 1000ms depending on operating pressure, pilot valve (option) and exhaust air throttle (option)
<b>Einbaulage</b>	beliebig	<b>mounting</b>	in any position

**2/2-Wege Coaxialventil**  
*2/2-way coaxial valve*
**Baureihe 283-X**  
**Type 283-X**

Baureihe type	DN [mm]	Druck pressure range [bar]	Anschluss connection	K <sub>v</sub> -Wert flow rate [m <sup>3</sup> /h]	Gewicht - Messing weight - brass [kg]
283-X	15	0 – 200	G3/8, G1/2, G3/4	7,2	3,2

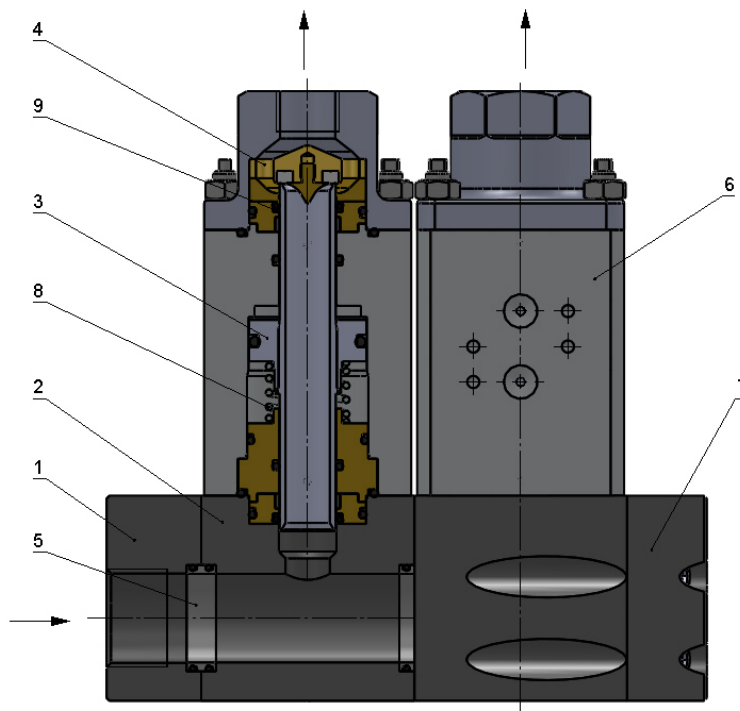
**Schnittzeichnung**  
*sectional drawing*

Pos. pos.	Menge quantity	Benennung	description
1	1	Anschlussstück links	<i>fitting left</i>
2	2	Blockmodul	<i>block module</i>
3	2	Kolben	<i>piston</i>
4	2	Ventilsitz	<i>valve seat</i>
5	3	Distanzstück	<i>distance piece</i>
6	2	Zylinder	<i>cylinder</i>
7	1	Abschlussdeckel	<i>end cover</i>
8	1	Feder	<i>spring</i>
9	2	PTFE-Stangendichtung	<i>PTFE-rod seal</i>

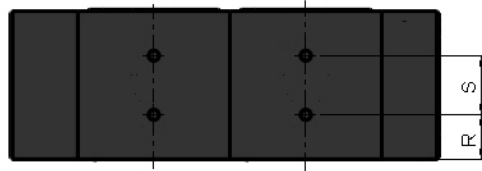
**2/2-Wege Coaxialventil**  
*2/2-way coaxial valve*
**Baureihe 283-X**  
*Type 283-X*
**Maßzeichnung**  
*dimension drawing*

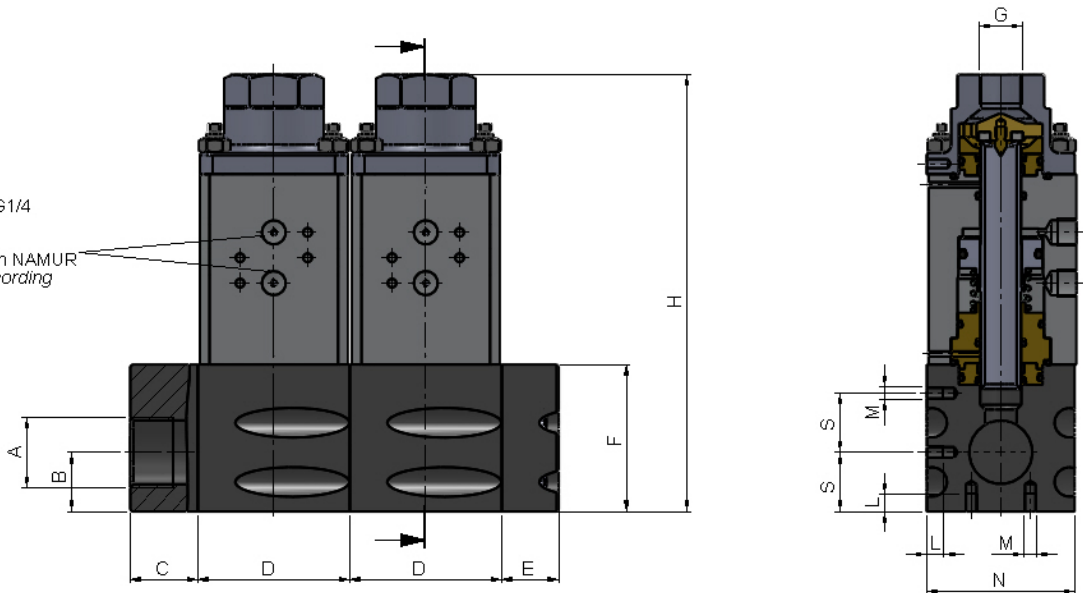
 Steueranschluss G1/4  
*control part G1/4*

 Anschlussbild nach NAMUR  
*mounting face according to NAMUR*

DN	A	B	C	D	E	F	H	G	L	M	R	S	N
[mm]	[mm]	[mm]	[mm]	[mm]	[mm]	[mm]	[mm]		[mm]	[mm]	[mm]	[mm]	[mm]
15	G1 1/4	28	32	72	27	69,5	207	3/8 - 1/2 - 3/4	8	M6	21	28	70

## 2/2-Wege Coaxialventil 2/2-way coaxial valve



## Baureihe 283-X Type 283-X

### Typenschlüssel type code

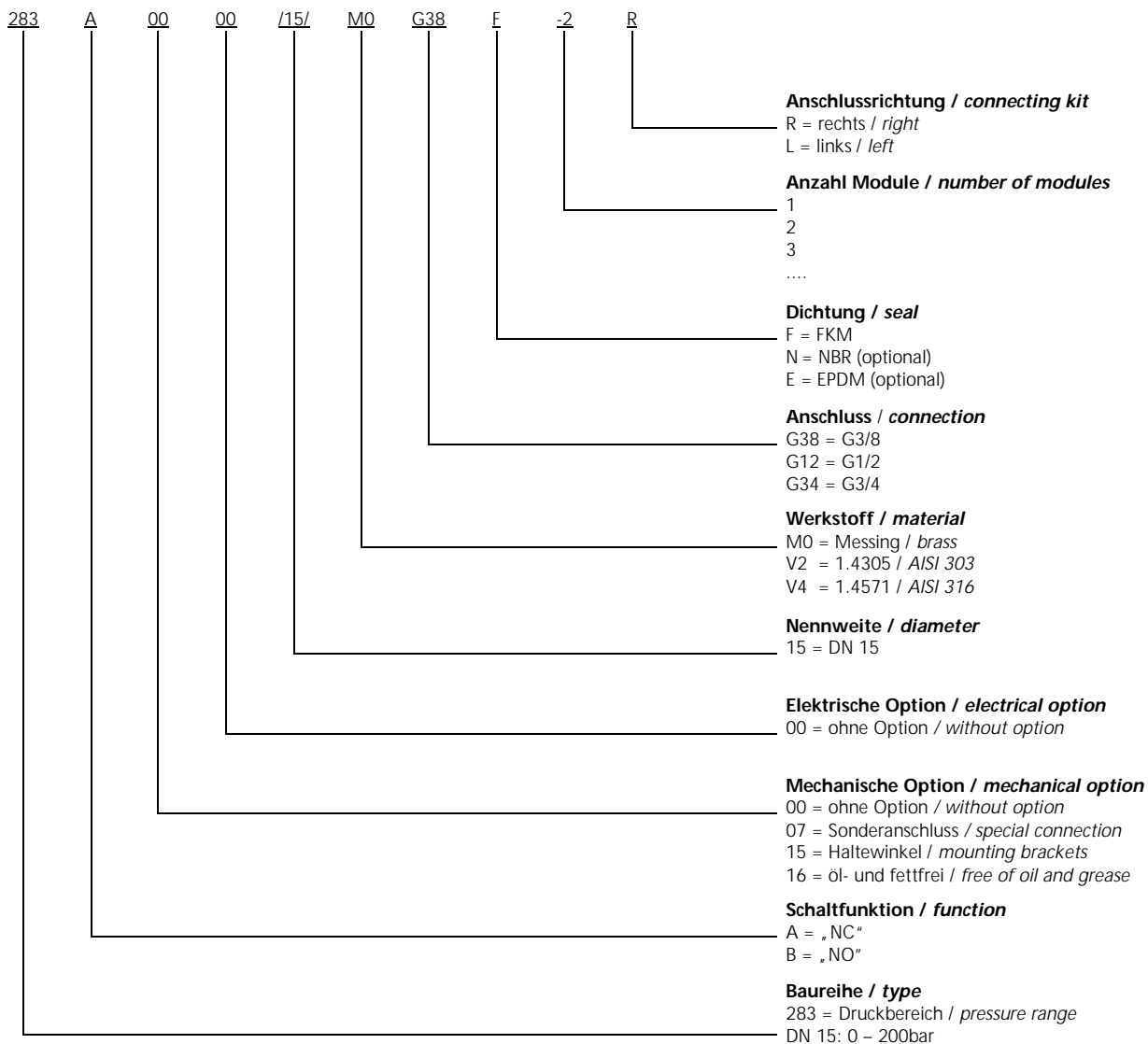
Die Typenbezeichnung setzt sich zusammen aus:  
structure of the order specification:

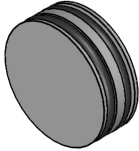
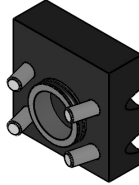

**2/2-Wege Coaxialventil**  
*2/2-way coaxial valve*
**Baureihe 283-X**  
*Type 283-X*
**Zubehör**  
*accessories*

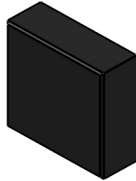
Verbindungsstücke <i>connecting pieces</i>		Abschlussstücke <i>end covers</i>	
	<b>Trennscheibe</b> <i>isolation disc</i>		<b>Abschlussstück rechts</b> <i>end cover right</i>
	<b>Distanzstück</b> <i>distance piece</i>		<b>Abschlussstück links</b> <i>end cover left</i>

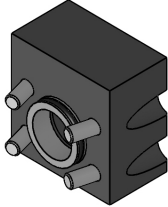
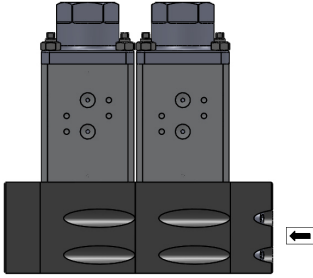
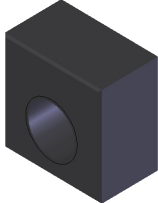
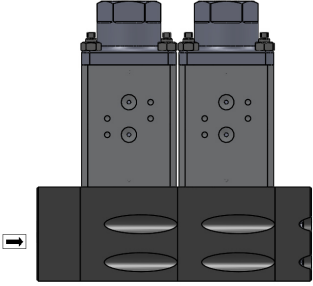

Anschlussstücke <i>connection parts</i>		
	<b>Anschlussstück rechts</b> <i>connection part right</i>	
	<b>Anschlussstück links</b> <i>connection part left</i>	

**2/2-Wege Coaxialventil**  
*2/2-way coaxial valve*

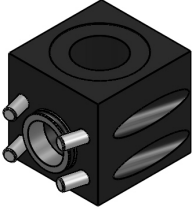
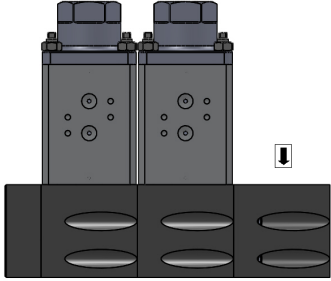
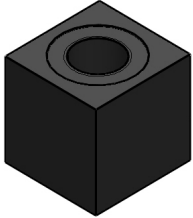
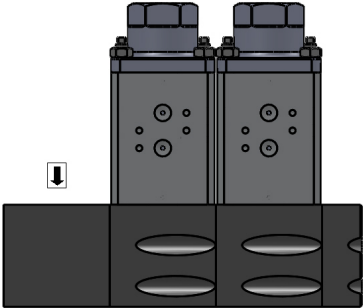

**Baureihe 283-X**  
*Type 283-X*

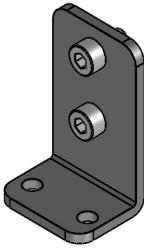
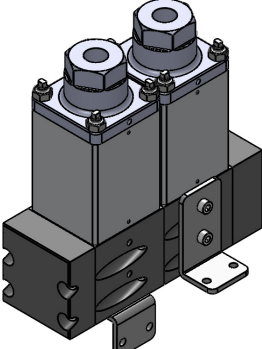
	<p><b>Anschlussstück rechts</b>  <b>Eckausführung</b>  <b>nach oben</b>  <i>connection part right 90°</i></p>	
	<p><b>Anschlussstück links</b>  <b>Eckausführung</b>  <b>nach oben</b>  <i>connection part left 90°</i></p>	

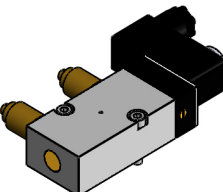
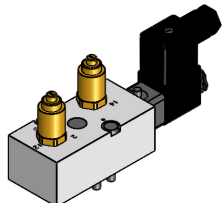
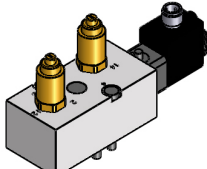
**2/2-Wege Coaxialventil**  
*2/2-way coaxial valve*
**Baureihe 283-X**  
*Type 283-X*

Weitere Optionen <i>further options</i>		
	<p><b>Haltewinkel</b> <i>mounting brackets</i></p> <p><b>mechanische Option = 15</b> <i>mechanical option = 15</i></p>	
	<p><b>Abluftdrossel</b> <i>exhaust air throttle</i></p> <p><b>G1/8</b> <b>G1/4</b></p>	
	<p><b>Schalldämpfer Sinterbronze</b> <i>silencer of sinter bronze casting</i></p> <p><b>G1/8</b> <b>G1/4</b></p>	
	<p><b>5/2-Wege Pilotventil (NAMUR)</b> <b>zum Anflanschen</b> <b>Anschlüsse seitlich</b> <i>5/2-way pilot valve (NAMUR) to flange connections laterally</i></p> <p><b>24V DC</b> <b>230V 50Hz</b></p>	
	<p><b>5/2-Wege Pilotventil (NAMUR)</b> <b>zum Anflanschen</b> <b>Anschlüsse oben</b> <i>5/2-way pilot valve (NAMUR) to flange connections above</i></p> <p><b>24V DC</b> <b>230V 50Hz</b></p>	
	<p><b>5/2-Wege Pilotventil (NAMUR)</b> <b>zum Anflanschen</b> <b>Anschlüsse oben</b> <b>Magnet M12x1</b> <i>5/2-way pilot valve (NAMUR) to flange connections above solenoid M12 x 1</i></p> <p><b>24V DC</b> <b>230V 50Hz</b></p>	

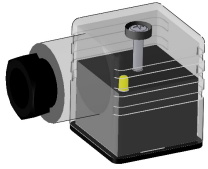
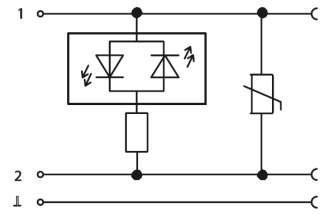
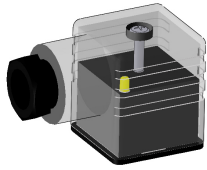
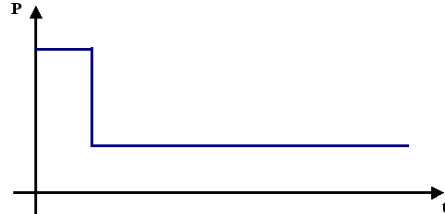
**2/2-Wege Coaxialventil**  
*2/2-way coaxial valve*
**Baureihe 283-X**  
**Type 283-X**

	<p><b>Gerätesteckdose mit LED</b>  <i>plug with LED</i></p> <p><b>elektrische Option = 20</b>  <i>electrical option = 20</i></p>	
	<p><b>Gerätesteckdose mit Leistungsabsenkung</b>  <b>24V DC</b>  <b>Bauform A</b>  <i>plug with power reduction</i>  <i>form A</i></p> <p><b>elektrische Option = 07</b>  <i>electrical option = 07</i></p>	
	<p><b>Sonderschutzart</b>  <i>explosion proof</i></p> <p><b>II 2G Ex m II T4</b>  <b>II 3D IP65 T130°C</b></p> <p><b>elektrische Option = 13</b>  <i>electrical option = 13</i></p>	

**Weitere Optionen und Zubehör stimmen wir gerne auf Ihre Anforderungen ab.**  
*We gladly coordinate further options and accessories according to your requirements.*